

Ex ResistTel IP2/IP154 **ResistTel IP2/IP152**



Explosion proof and weatherproof VoIP-telephones



Short Manual

Brand names are used with no guarantee that they may be freely employed. Almost all hardware and software designations in this manual are registered trademarks or should be treated as such.

All rights reserved. No part of this manual may be reproduced in any way (print, photocopy, microfilm or by any other means) or processed, duplicated or distributed using electronic systems without explicit approval.

Texts and illustrations have been compiled and software created with the utmost care, however errors cannot be completely ruled out. This documentation is therefore supplied under exclusion of any liability or warranty of suitability for specific purposes. FHF reserves the right to improve or modify this documentation without prior notice.

Note

Please read the operating manual carefully before installing the device.

This is only a short manual. The most important operating procedures and the mounting and installation instructions are part of this document. For the complete configuration and operating of all features the knowledge of the complete manual is necessary.

The complete manual is attached on the CD.

Please check the contents of the box for completeness.

Table of Contents

1	VoIP Telephone ResistTel IP2 / IP152 and ExResistTel IP2 / IP154.....	4
1.1	Keypad.....	4
1.2	Keypad Description	5
1.3	Display.....	6
11.3.1	Default Display.....	6
21.3.1	Menu and Listing Display	7
1.4	As-Delivered Condition	8
11.4.1	Default Version one LAN Connection Fehler! Textmarke nicht definiert.	
21.4.1	Version one Switch LAN Module with two LAN Connections Fehler! Textmarke nicht definiert.	
1.5	Mounting and Installing.....	8
11.5.1	LAN-Connections.....	13
1.5.1.1	Default Version one LAN Connection with a Cable Gland	13
1.5.1.2	Version with Switch LAN Module with two LAN Connections with Cable Glands.....	13
21.5.1	External Power Supply Connection	14
31.5.1	Relay Connection	14
41.5.1	Other Terminals	15
51.5.1	Sling Holder	Fehler! Textmarke nicht definiert.
61.5.1	General.....	Fehler! Textmarke nicht definiert.

2	Operating Manual.....	16
2.1	Operating Basics	16
12.1.1	Adjusting the Volume	16
22.1.1	Adjusting the Ringer Volume.....	17
32.1.1	Do not disturb.....	17
42.1.1	Different Types of Call Numbers.....	18
52.1.1	Input of Characters and Special Characters.....	18
2.2	Operating Modes	19
12.2.1	Changeover from Handset Mode to Handset Mode with Open Listening.....	19
22.2.1	Changeover from Handset Mode with Open Listening to Handset Mode.....	19
32.2.1	Changeover from Handset Mode (with or without Open Listening) to Hands Free Mode	20
42.2.1	Changeover from Handset Mode (with or without Open Listening) to Headset Mode.....	20
52.2.1	Changeover from Hands Free Mode to Handset Mode.....	20
62.2.1	Changeover from Hands Free Mode to Headset Mode.....	20
72.2.1	Changeover from Headset Mode to Headset Mode with Open Listening.....	20
82.2.1	Changeover from Headset Mode with Open Listening to Headset Mode.....	20
92.2.1	Changeover from Headset Mode (with or without Open Listening) to Handset Mode.....	20
102.2.1	Other Changeover of the Operating Mode.....	20
2.3	Call Functions	21
12.3.1	Answering Calls.....	21
22.3.1	Terminating a Call	21
32.3.1	Making Calls.....	21
2.3.3.1	Single Dialling	22
2.3.3.2	Block Dialling	22
2.3.3.2.1	Menu Parameter Input Indirect Dialling	23
2.3.3.3	Dialling during existing Connections.....	24
42.3.1	Redialling.....	24
52.3.1	Call Back.....	25
62.3.1	Muting.....	26
72.3.1	Making second Call.....	26
82.3.1	Switching.....	27
92.3.1	Transferring a Call.....	27
102.3.1	Transferring a Call directly	28
112.3.1	Initiating a Conference	28
3	Technical Data weatherproof Telephones	30
3.1	CE symbol	31
3.2	Use in marine and offshore segments	31

1 VoIP Telephone ResistTel IP2 / IP152 and ExResistTel IP2 / IP154

1.1 Keypad

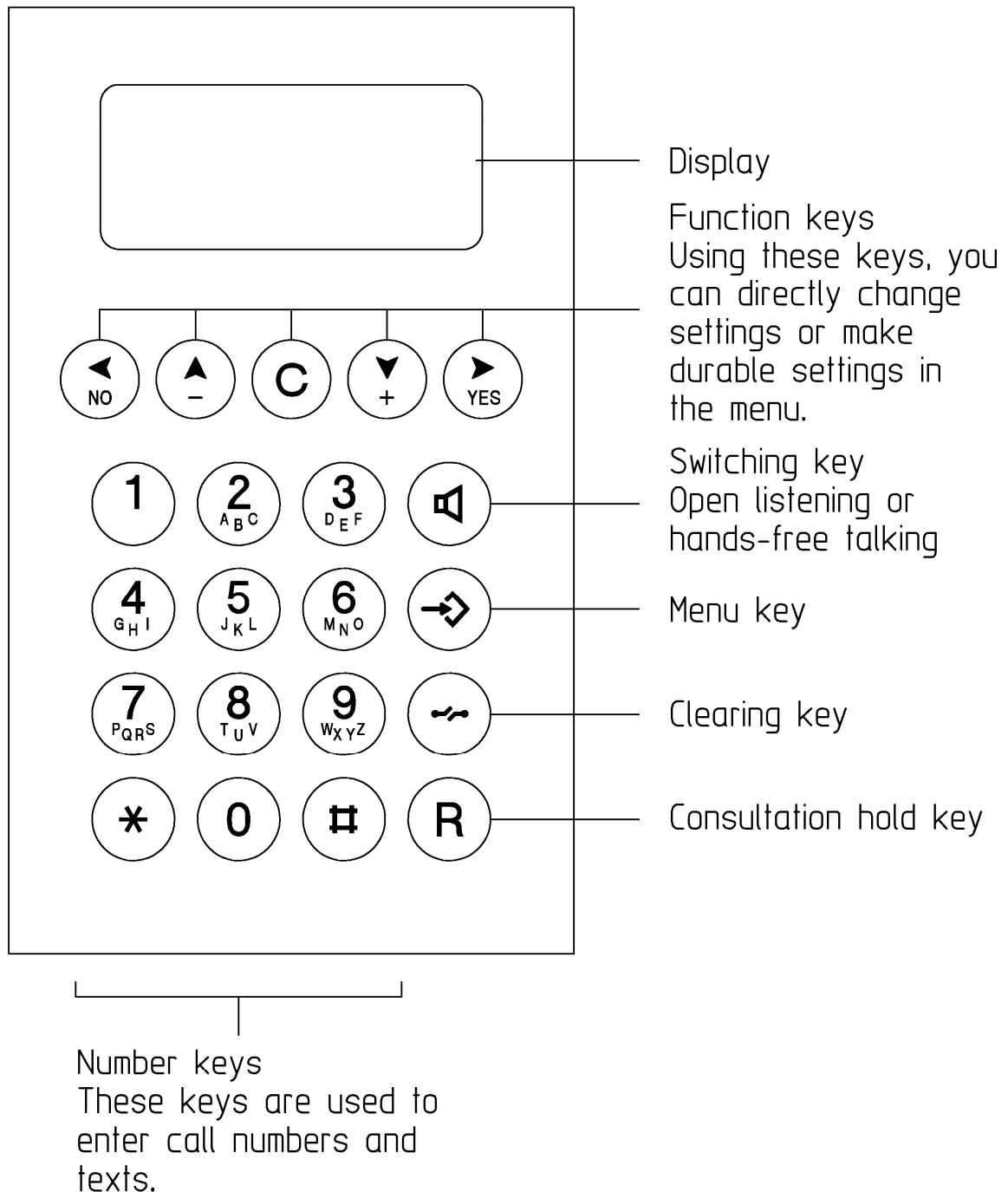

Figure 1: Keypad of the VoIP-Telephone

1.2 Keypad Description













Symbol	Description and Key Functions
	The Loudspeaker key is used to control the hands free and listening mode.
	The Menu key is used to open the main menu or to save changes.
	The Disconnect key is used to terminate calls or any menu.
 (short)	The Enquiry key is used to enable the "Hold" and "Switch" functions. In idle mode, the Enquiry key is used to call up the list of missed calls. To execute the enquiry function the Enquiry key has to be pressed short (shorter than 0.5 seconds).
 (long)	The Redial key is used to select the list of 100 phone numbers last dialled. In the menu, the redial key confirms the current selection. The telephone has no single Redial key. To execute the redial function the Redial key has to be pressed long (longer than a second).
	Arrow keys are used for navigation in the menu and browsing in the telephone directory. The volume can only be adjusted during a call.
 (long)	The asterisk key also serves as a mute key. During a call, a longer press switches the microphone off or on.
	Digit keys for entering phone numbers. The asterisk and hash keys have special functions. To enter asterisk and Hash the keys have to be pressed short (shorter than 0.5 seconds). To enter Mute (asterisk) and Shift (hash) the keys have to be pressed long (longer than a second). After pressing of shift the digit keys (1 – 9 and 0) become function keys (F1 – F10). After executing a function key the shift mode is ended.
	The Clearing key is used in input mode to delete the characters left to the cursor.
 (long) 	The headset key is used to make and to end a call in the headset mode. The phone ResistTel IP2 / IP152 has no single headset key. To execute the headset key function the key  has to be pressed long (longer than a second) and then the loudspeaker key  has to be pressed. The headset key can be used only, if the headset is configured to on (see manual). This makes sense only, if a headset is connected to the phone.

Table 1: Keys and Function Elements

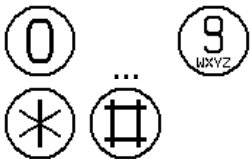
1.3 Display

The displays of the VoIP Telephones ResistTel IP2 / IP152 and ExResistTel IP2 / IP154 have 7 lines with max. 30 characters and a state line for showing information.

1.3.1 Default Display

The name and telephone number of the current registration is displayed in the first line.

The middle lines display special information relating to the condition.

The date, time and registration status is displayed in the last line.

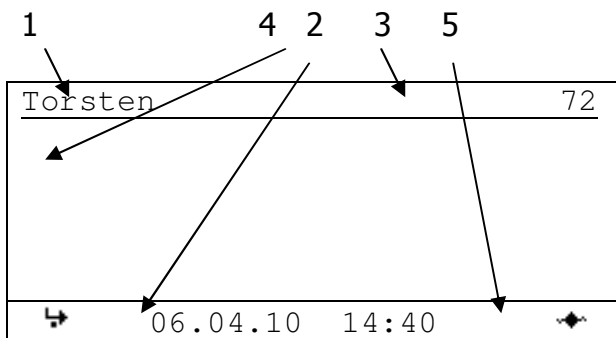

Figure 2: Default Display (Idle State)

In the busy state state-information, date, time and the duration of the active connection are displayed in the last line.

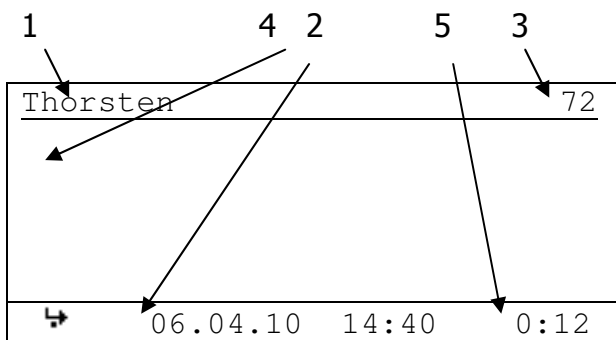

Figure 3: Default Display (Busy State)

Position	Symbol	Description
1		Name (H.323 or SIP ID or nickname of the PBX configuration)
2		Status line; provides information on the current status of the telephone by means of the following symbols.
	06.04.10	Date
	14:00	Time
	☐	No connection to the gatekeeper
	◆	Connection established to the gatekeeper
	◇	Connection established to the secondary gatekeeper
	◆ ◇	Connection to the gatekeeper broken. (Both symbols are displayed in mutual change)
	☐	Open listening
	☐	Hands free Mode
	☐	Microphone switched off (symbol flashing)
	↔	Call diversion activated
	☐	Handset activate
	☐	Headset active
	☐	Telephone locked
	☐	Calling number transmission locked
3		Own call number (E.164)
4	△	Called party
	☐	Calling party
	—	Unknown number/name, unresolved number
	↔	Diverting party
	+	Transferring party
	↻	Returning call
	→	Call pending
	☐	Call on hold
5	↑	Shift Mode
	☐	Headset configured
	☐	Audio connection of the active call is scrambled (SRTP)
	0:12	Duration of the active call

Table 2: Contents of the Default Display

1.3.2 Menu and Listing Display

The first six lines are used for the menu and listing display.

The last line is used for display of menu level, display name, scroll information and type of entry.

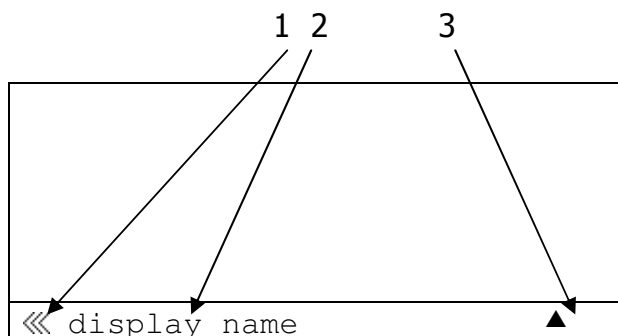

Figure 4: Menu and Listing Display of the VoIP Telephone

Position	Symbol	Description
1		Menu or listing level 0
	<	Menu or listing level 1
	◀	Menu or listing level 2
	◀◀	Menu or listing level 3
	◀◀◀	Menu or listing level 4 or lower
2		Display name
3	▲	Scrolling up possible
	⬆	Scrolling up and down possible
	▼	Scrolling down possible
	a	Alphanumerical input
	1	Numerical input
		Choice, next level

Table 3: Contents of the Menu and Listing Display

1.4 As-Delivered Condition

The phone is available for delivery in different versions.

- Handset with armed or spiral court
- ZB – Version (without keypad)
- Single LAN connection (1 x LAN female connector for cable mounting)
- Switch LAN module with two LAN connections (2 x LAN female connector for cable mounting)
- Optional: relay module

Accessories (optional):

- Headset with connection cable and attachment of the bracket.
- connecting cable RJ45 - RJ45
- LAN female connector for cable mounting
- Cable glands
- Sealing plugs

The scope of the delivery includes:

- Telephone
- Printed short manual
- Manual on CD
- 1 LAN resp. 2 LAN female connector for cable mounting

1.4.1 Sling Holder

The holding strength for the handset is continuously adjustable.

Loosen the screws (12) and move the stopping catches (13) (See Figure 6 on page 10). Pushing the stopping catches together increases the holding strength whereas pulling them apart reduces it. Tighten the screws again.

1.4.2 General

The receiver is equipped with a leakage field spool for coupling of hearing aids. Users of a hearing aid with inductive receiver may receive the signal from the receiver inset directly.

1.5 Mounting and Installing

The device must be installed on a plane surface only, in vertical operating position. Loosen the cover screws (2) (see Figure 6 to Figure 8) and detach the upper part of the telephone (1). If the optional accessory headset or a second earpiece is being employed, attach the bracket (10) using two screws (11) to the rear panel of the lower part of the telephone. (With the accessories named before, the bracket and screws are in the scope of delivery. With all accessories a cable gland is delivered.) Put four screws, having a head diameter of 10 to 13 mm into the holes (20) and attach the lower part of the telephone (3) to the wall or to a holder.

The telephone network cable should be passed through the cable entry (4) and connected to terminals in accordance with the connection diagram. The attached operating instructions for cable glands have to be considered.

Prior to assembly, check cover seal for tightness. Using the plug connector (7), plug the ribbon cable onto the pin contact strip (8) in the upper part of the housing. Attach the upper part of the telephone and fasten it to the lower part of the telephone with the four cover screws (2). Upon disassembly of optional accessories, suited sealing plugs must be used to close the resulting openings.

In this telephone connected cords may have hazardous voltages.

To ensure that no water gets into the enclosure it is essential that no gaskets are damaged during installation. The ingress of water can cause accessible parts of the telephone to become live.

Installation and connection must be carried out by competent personnel familiar with electrical and network installations.

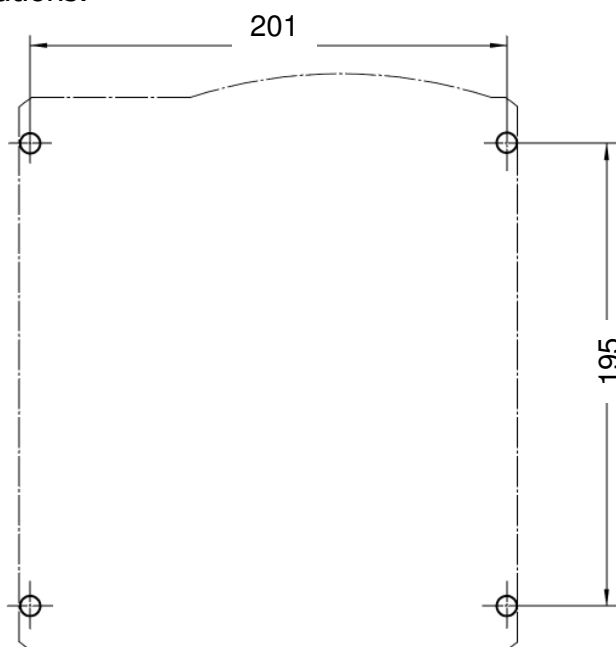

Figure 5: Drilling Diagram Wall Mounting

The diameter of the drilled hole is dependent on the screw employed (screw diameter max. 8 mm) and the type of supporting base material (steel, wood, concrete, plasterboard etc.) and must be chosen accordingly.

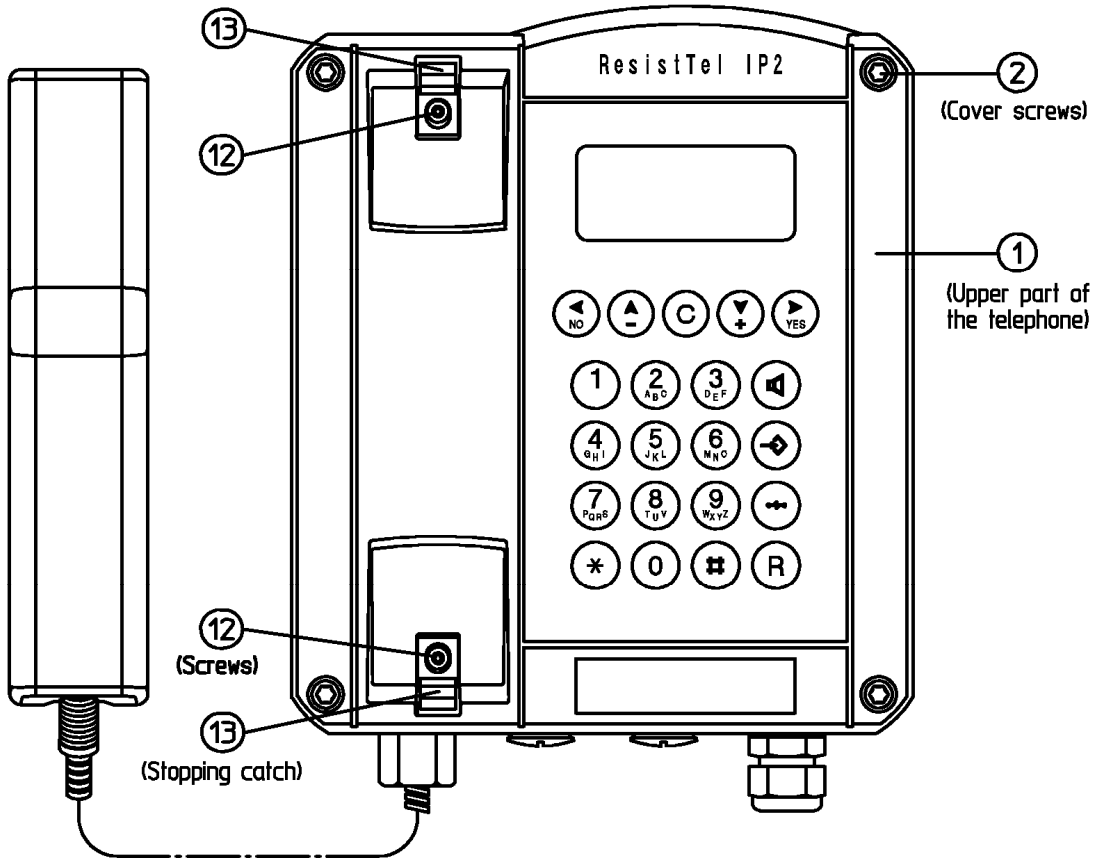

Figure 6: Set View

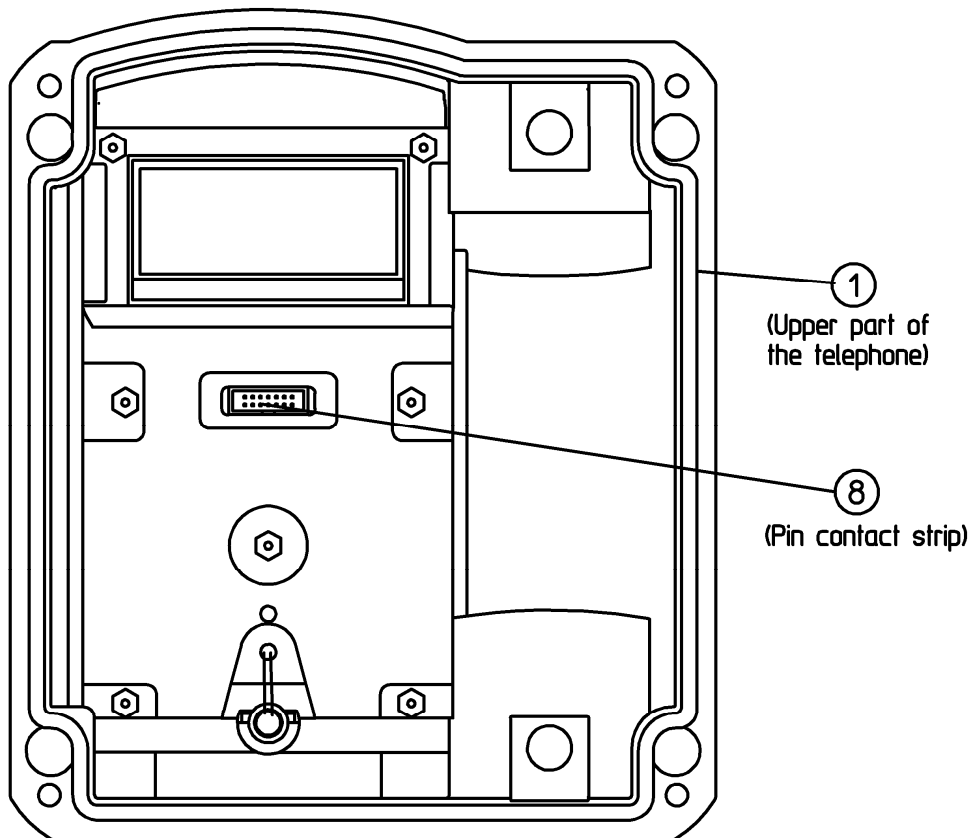

Figure 7: Inside View of Telephone upper Part

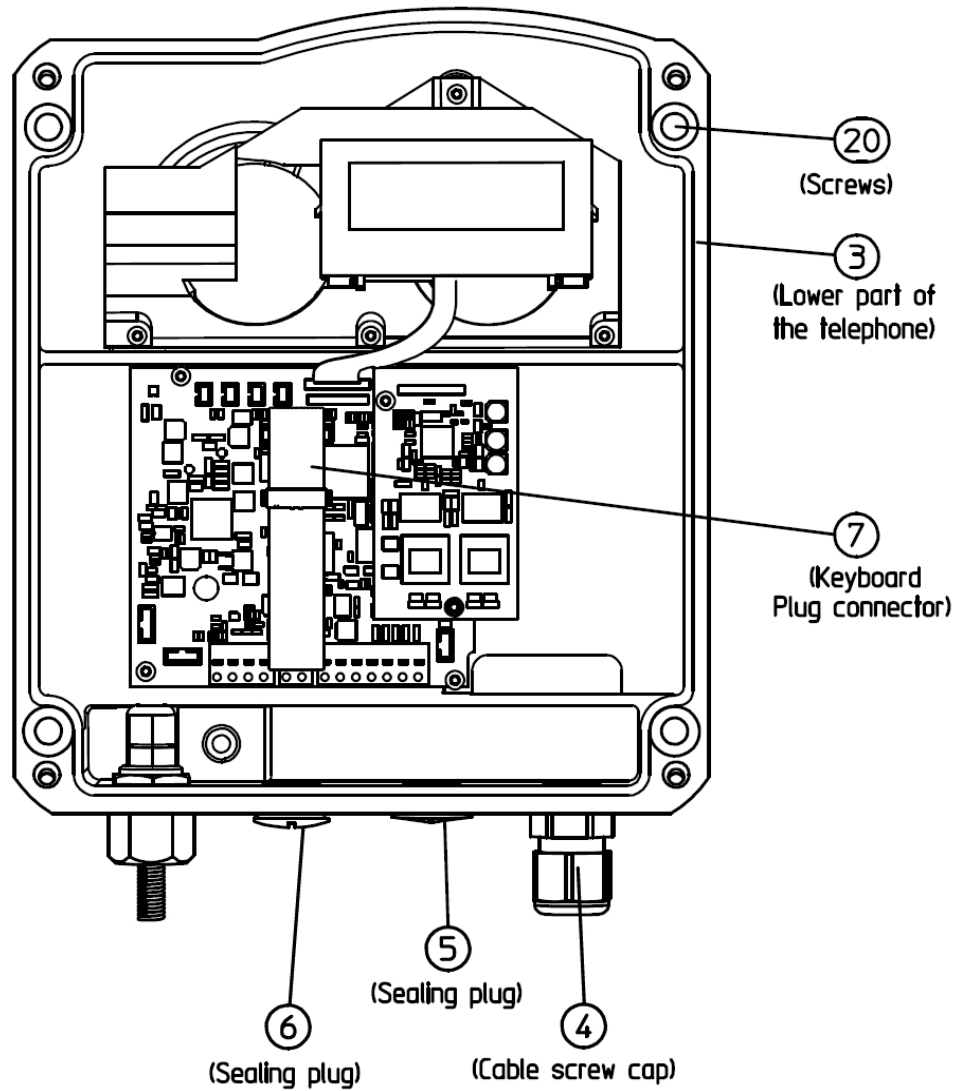

Figure 8: Inside View of Telephone lower Part

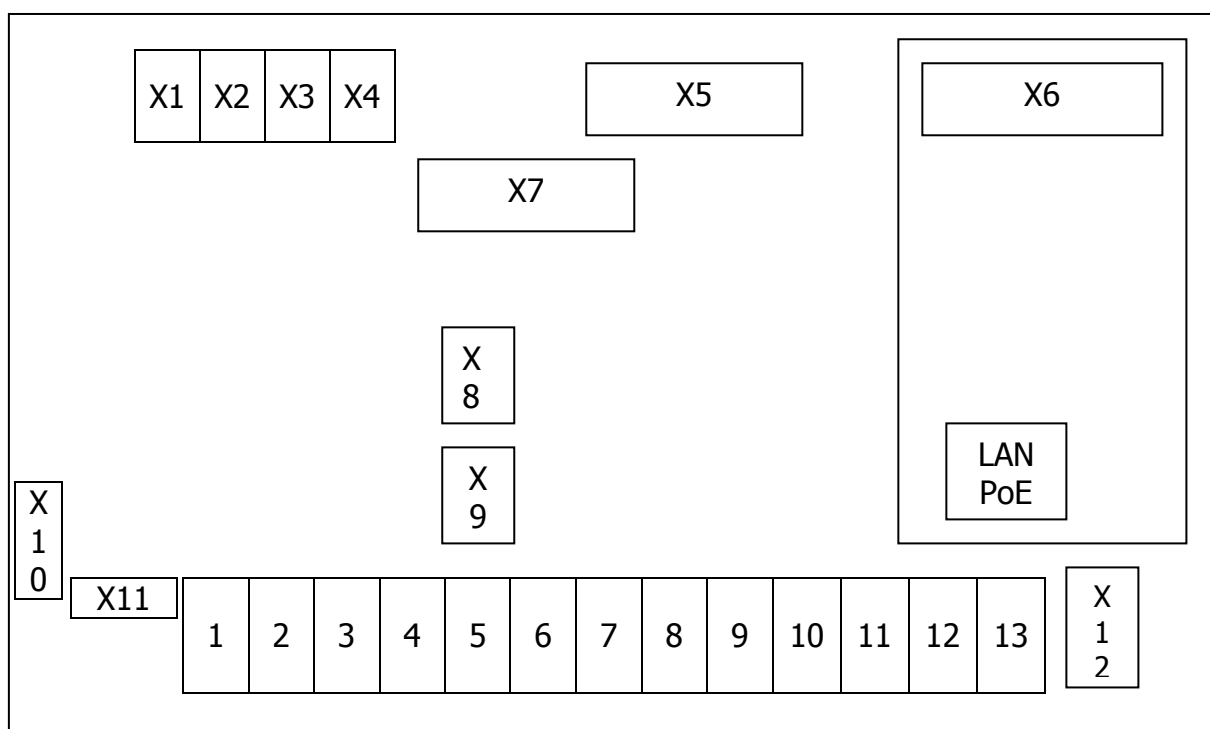

Figure 9: Connection Diagram with Single LAN Module

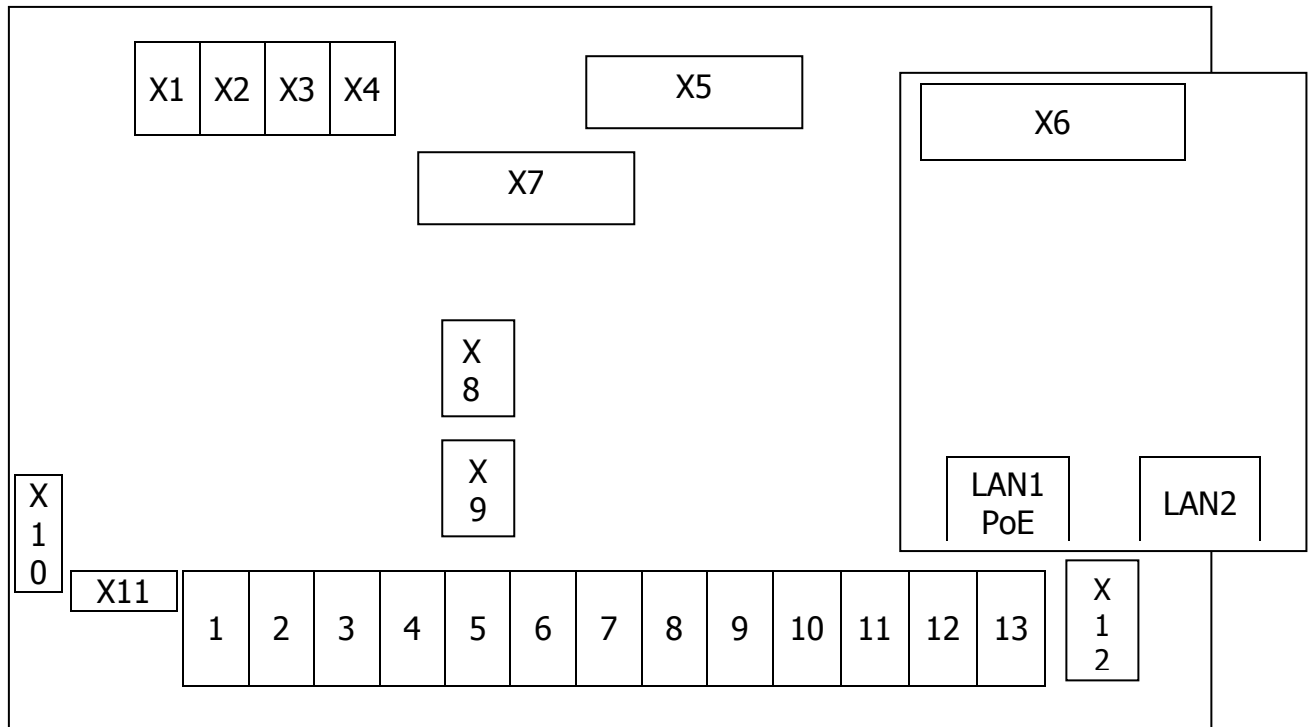

Figure 10: Connection Diagram with Switch LAN Module

Connector	Description
X1	empty
X2	Loudspeaker (left)
X3	Heater of the Display
X4	Illumination of the Display
X5	Display
X6	LAN Module
X7	Keypad
X8	Hookswitch (Reed Contact)
X9	RS232 Module (optional)
X10	Amplifier Module (optional)
X11	Handset
X12	Relay Module (optional)
LAN PoE	LAN with PoE (LAN-Link, single LAN Module)
LAN1 PoE	LAN1 with PoE (LAN-Link, Switch LAN Module)
LAN2 (PC)	LAN2 (PC-Link, Switch LAN Module)
1 - 13	Terminals (Configuration see the following Chapters)

Table 4: Plug in Connectors and Terminals of the ResistTel IP2 / IP152 with Hardware-ID: 103

1.5.1 LAN-Connections

1.5.1.1 Default Version one LAN Connection with a Cable Gland

The telephone has in the default version one internal LAN-connection with a Cable Gland. For the connection a LAN cable must be pulled through the Cable Gland. Inside the phone the female LAN connection from AMP NETCONNECT (TE Connectivity) has to be pressed on the cable (Refer to chapter 1.4 beginning on page 8). A female LAN cable connector belongs to the as-delivered condition. With the inside the phone existing little LAN connection cable, the LAN can be connected with the phone.

The LAN delivery can be available with PoE (Power over Ethernet). Alternatively the phone can be supplied with power external.

All not used cable feed through have to be closed with sealing plugs.

Caution



You can use PoE (Power over Ethernet) or an external connection to supply the ResistTel IP2 / IP152 with power.

Don't use both at the same time, to prevent damage to the equipment.



1.5.1.2 Version with Switch LAN Module with two LAN Connections with Cable Glands

The telephone has in this version two internal LAN-connections with a Cable Gland. For the connection the LAN cable must be pulled through the Cable Gland. Inside the phone the female LAN connection from AMP NETCONNECT (TE Connectivity) has to be pressed on the cable (Refer to chapter 1.4 beginning on page 8). A female LAN cable connector belongs to the as-delivered condition. With the inside the phone existing little LAN connection cable, the LAN can be connected with the phone.

The LAN1 delivery can be available with PoE (Power over Ethernet). Alternatively the phone can be supplied with power external.

The LAN2 delivery doesn't support PoE. Also it can't be used to connect a phone directly, which should be powered with PoE.

All not used cable feed through have to be closed with sealing plugs.

1.5.2 External Power Supply Connection

An external power supply can be adapted to the terminals 5 (+) and 6 (-). The voltage has to be:

- Without using the optional voltaic separated inputs: 15 V – 57 V DC, 12.95 W
- With using the optional voltaic separated inputs: 21,5 V – 57 V DC, 12.95 W

If the external power connection will be used, you must not use PoE at the LAN connection.

1.5.3 Relay Connection

The phone can be build up with a relay module with two relays with a single changeover switch optional.

The maximal breaking capacity of a relay is depending on the voltage:

- 240 V, 6 A, AC
- 24 V, 6 A, DC
- 32 V, 5 A, DC
- 48 V, 1 A, DC

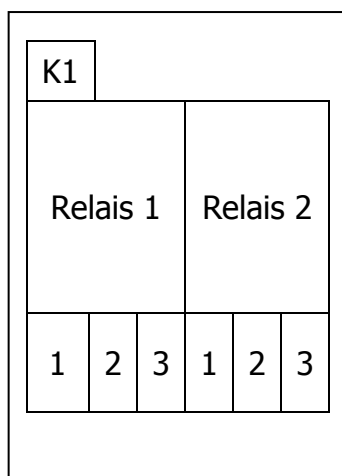



Figure 11: Connection Diagram Relay Module

	<p>Caution</p> <p>Do not open the housing of the telephone while the relay contacts are energized.</p>	
---	---	---

Connector	Description
K1	Cable to the main board (connection to plug in X12)
1 (relay 1)	Idle contact relay 1
2 (relay 1)	Base contact relay 1
3 (relay 1)	Switching contact relay 1
1 (relay 2)	Idle contact relay 2
2 (relay 2)	Base contact relay 2
3 (relay 2)	Switching contact relay 2

Table 5: Plug in Connectors and Terminals of the Relay Module of the Telephone ResistTel IP2 / IP152

Pay particular attention to the following points if hazardous voltages (>48V) are to be connected to the relay outputs:

- Cable and cords must be insulated and have to be conducted below the cover.
- The circuits that the relay outputs are connected to must be of the same type; i.e. both mains, both SELV or both TNV circuits.
- It is not permissible to connect different types of circuits to these relays.



1.5.4 Other Terminals

The terminals 1 – 4 are for connecting a headset. A detailed description is enclosed in the manual.

The terminals 7 – 13 five voltaic separated inputs are provided. All of the voltaic separated inputs have a common null potential. Closing contacts (e. g. external push-buttons) can be connected at the inputs. The maximum switching load for the closing contacts is 60 V DC, 10 mA.

Terminal	Description
7	Null potential of the voltaic separated inputs
8	Null potential of the voltaic separated inputs
9	Input 1
10	Input 2
11	Input 3
12	Input 4
13	Input 5

Table 6: Terminals of the voltaic separated Inputs

	<p>Caution</p> <p>While using the voltaic separated inputs with external power supply, the input voltage has to be 21.5 V – 57 V DC.</p>	
---	---	---

2 Operating Manual

2.1 Operating Basics

The keys below the display (◀ ▶ Ⓞ ▲ ▼) of the VoIP telephone serve menu navigation and, for edit field input purposes, are assigned an additional function on top of their actual function, as explained below.

Key assignment in menu:

The function is performed by ...
scrolling upwards	Arrow key up ▲
scrolling downwards	Arrow key down ▼
one level up without saving	Arrow key left ◀
one level down	Arrow key right ▶
one level up with saving	Menu key Ⓞ
Leave the menu complete immediately	Disconnect key ☎

Key assignment in edit field:

The function is performed by ...
scrolling right	Arrow key right ▶
scrolling left	Arrow key left ◀
Delete character in front of cursor	Clearing key Ⓞ

Pressing and holding the numeric key, activates the **character mode**. Refer to chapter 2.1.5 Input of Characters and Special Characters beginning on page 18.

The **initial condition** means that the telephone is in the switching state hang up. This state consists if the following conditions are fulfilled:

- a) The telephone is hanged up or will be hanged off and then the key ☎ will be pressed.
- b) The hands free mode isn't active.
- c) The headset mode isn't active.

2.1.1 Adjusting the Volume

You can adjust the volume while establishing connections as well as during calls. The volume remains on this level after the call. The "Vol." indicator shows the current value (see Figure 12).

You can increase the volume level by pressing the key ▶.

You can reduce the volume level by pressing the key ◀.

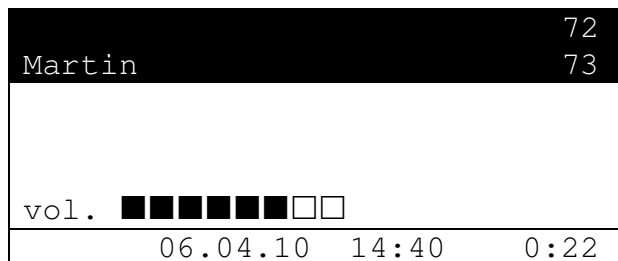

Figure 12: Adjusting the Volume

You control the volume of the active mode.

- At the handset mode you control the volume of the speaker of the handset.
- At the listening mode you control the volume of the additional connected speaker of the phone.
- At the hands free mode you control the volume of the speaker in hands free mode.
- At the headset mode you control the volume of the speaker of the headset.

2.1.2 Adjusting the Ringer Volume

You can adjust the ringer volume while incoming calls concerning to the actual call type (internal, external). The ringer volume remains on this level after the call. The "Vol." indicator shows the current value (see Figure 13).

You can increase the ringer volume level by pressing the key .

You can reduce the ringer volume level by pressing the key .

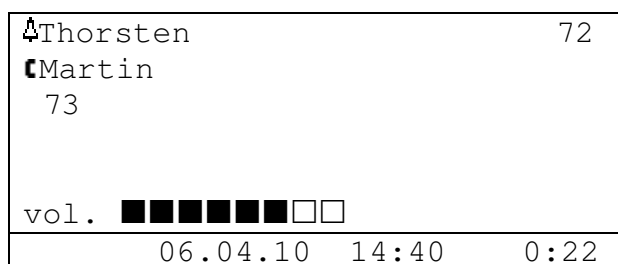



Figure 13: Adjusting the Ringer Volume

2.1.3 Do not disturb

You can turn off the do not disturb function of the VoIP telephone ResistTel IP2 / IP152 simply by pressing a key, for example if you do not wish to be disturbed during a meeting.

1. To activate the do not disturb function; press the key  for about a second whilst in idle mode until the display appears in Figure 14. The telephone reacts to an incoming call depending on how this feature is configured at the time. For further details on how to configure the do not disturb feature (see manual).

- To deactivate the do not disturb function again; press the key  again for about a second until the signalling in the display is deleted. Afterwards the device will respond to calls in the usual way again.

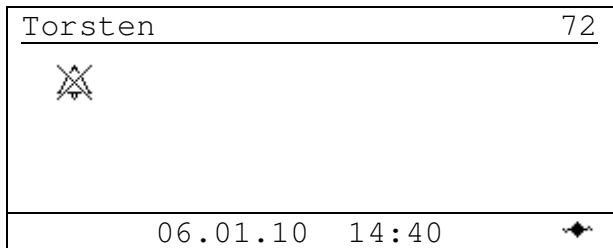

Figure 14: Do not disturb

2.1.4 Different Types of Call Numbers

In addition to normal call numbers, your VoIP telephone can also dial H.323 names and IP addresses.

Call numbers consisting of characters other than the digits 0 to 9 and the characters * and # are considered to be H.323 names. Call numbers beginning with the character @ are always regarded as H.323 names. The @ is removed before dialling however.

2.1.5 Input of Characters and Special Characters

You can enter any Western European characters in accordance with ISO 8859-1 using the keypad. The assignment of the characters and special characters to the keys can be seen in Table 7.

The letter mode is activated by pressing the respective key pad for an extended moment of time. Subsequently, it is possible to switch between the letters by pressing the key several times in short intervals or by keeping the key pressed.

key	possible characters and special characters
1	1 + () , - & @ # ` * ! \$ % . / : ; < = > ? ' [] \ ^ _ ` { } ~ £ § ¢ ÷
2	2 a b c A B C ä à á â ã ä å æ ç Ä Å Ã Ä Å Æ Ç
3	3 d e f D E F è é ê ë Ë É Ê Ë
4	4 g h i G H I ï í î ï Ì Í Î Ï
5	5 j k l J K L
6	6 m n o M N O ö ñ ò ó ô õ ø Ñ Ò Ó Ô Õ
7	7 p q r s P Q R S ß
8	8 t u v T U V ü ù ú û Ü Ù Ú Û
9	9 w x y z W X Y Z ý Ý ÿ
0	0 (space character)
*	*
#	#

Table 7: Input of Characters and Special Characters

2.2 Operating Modes

The telephone allows making calls in different operating modes.

1. Handset mode

At handset mode the call will be operated with the handset.

2. Handset mode with open listening

At handset mode with open listening the call will be operated with the handset. The hands free speaker of the phone will be connected additionally. Persons present in the room can listen to the call.

3. Hands free mode

At hands free mode the call will be operated with the hands free microphone and hands free speaker of the phone. All persons present in the room can take part to the call.

If a headset is connected and configured:

4. Headset mode

At headset mode the call will be operated with the headset.

5. Headset mode with open listening

At headset mode with open listening the call will be operated with the headset. The hands free speaker of the phone will be connected additionally. Persons present in the room can listen to the call.

The already active operating mode will be displayed in the state line of the phone.



2.2.1 Changeover from Handset Mode to Handset Mode with Open Listening

To change from handset mode to handset mode with open listening, you have to press the loudspeaker key  during a call.



2.2.2 Changeover from Handset Mode with Open Listening to Handset Mode

To change from handset mode with open listening to handset mode, you have to press the loudspeaker key  during a call.

2.2.3 Changeover from Handset Mode (with or without Open Listening) to Hands Free Mode

To change from handset mode (with or without open listening) to hands free mode, you have to press the loudspeaker key  and hang up the handset with pressed loudspeaker key . Afterwards the loudspeaker key  can be released.



2.2.4 Changeover from Handset Mode (with or without Open Listening) to Headset Mode

To change from handset mode (with or without open listening) to headset mode, you have to press the headset key (Key  long (longer than a second) and then the loudspeaker key ). Afterwards the handset can be hanged up.

2.2.5 Changeover from Hands Free Mode to Handset Mode

To change from hands free mode to handset mode, you have to lift off the handset.

2.2.6 Changeover from Hands Free Mode to Headset Mode

To change from hands free mode to headset mode, you have to press the headset key (Key  long (longer than a second) and then the loudspeaker key ).

2.2.7 Changeover from Headset Mode to Headset Mode with Open Listening

To change from headset mode to headset mode with open listening, you have to press the loudspeaker key  during a call.

2.2.8 Changeover from Headset Mode with Open Listening to Headset Mode

To change from headset mode with open listening to headset mode, you have to press the loudspeaker key  during a call.

2.2.9 Changeover from Headset Mode (with or without Open Listening) to Handset Mode

To change from headset mode (with or without open listening) to handset mode, you have to lift off the handset.

2.2.10 Other Changeover of the Operating Mode

Other changes of the operating mode can't take place directly. They are only possible with one of the above listed intermediate steps indirect.

2.3 Call Functions

2.3.1 Answering Calls



You receive a call and your phone rings. The name or phone number of the caller is displayed. The name or phone number of the person for whom the call is intended is also displayed. This is particularly useful in the event of multiple registrations on your telephone in order to identify the actual caller when a call is diverted to your telephone.

▲Torsten	72
■Martin	73
06.01.10 14:40 0:22	

Figure 15: Answering a Call

Answering or rejecting calls:

If you would like to answer the call, you have different possibilities:





- Lift the handset.
- Press the loudspeaker key .
- Press the headset key (Key  long (longer than a second) and then the loudspeaker key .

You will be connected to the caller.

To reject the call, press the key . The phone returns to the idle state and the caller will hear an engaged tone.

2.3.2 Terminating a Call

To finish a call respectively to the active operating mode:

- Put the handset back on its rest
- Press the key .
- Press the loudspeaker key .
- Press the headset key (Key  long (longer than a second) and then the loudspeaker key .

2.3.3 Making Calls

To call someone, you can use single or block dialling.

2.3.3.1 Single Dialling

For single dialling take the following steps:



Torsten	72
0211654321	
Please dial	
06.01.10	14:40 0:00

Figure 16: Direct Dialling

1. Respectively to the wanted calling mode:





Pick up the handset (handset mode).

Press the loudspeaker key  (hands free mode).

Press the headset key (Key  long (longer than a second) and then the loudspeaker key  (headset mode).

2. Enter the phone number. In this case the VoIP telephone dials the number while it is being entered.

3. To finish a call respectively to the active operating mode:



- Put the handset back on its rest (handset mode).
- Press the key  (All modes).
- Press the loudspeaker key  (hands free mode).
- Press the headset key (Key  long (longer than a second) and then the loudspeaker key  (headset mode).

2.3.3.2 Block Dialling

For block dialling do the following steps:

1. Let the handset on its rest and don't activate the hands free or headset mode.

2. Enter the phone number completely.

3. When entering the telephone number, you may edit already entered digits. Use the  and  keys to move the cursor, and the key  to delete the digit to the left of the cursor.

4. Respectively to the wanted calling mode, you can setup the call as follows. In this matter, it will be dialled after one of the following activities.

- a. Lift off the handset (handset mode).

- b. Press the loudspeaker key Ⓛ (hands free mode).
 - c. Press the headset key (Key Ⓜ long (longer than a second) and then the loudspeaker key Ⓛ) (headset mode).
 - d. Press the key Ⓜ or key Ⓡ (short or long). With a configured headset you will reach the headset mode otherwise the hands free mode.
 - e. Using the key Ⓡ (short or long) executes the selection immediately. Using the key Ⓜ , however, executes the selection only if the cursor is situated to the right of the last entered digit.
5. When using block dialling, you may enter further properties of the selection. Do so by pressing the Ⓢ key. See chapter 2.3.3.2.1 on page 23.

2.3.3.2.1 Menu Parameter Input Indirect Dialling

The following is displayed:

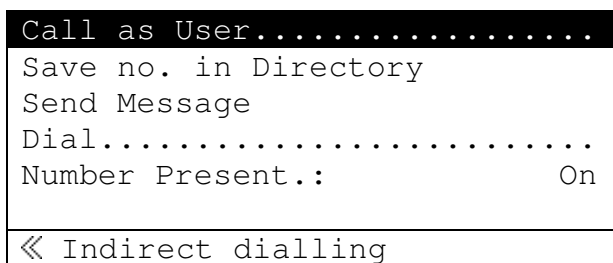

Figure 17: Menu Parameter Input Indirect Dialling

If you use the cursor keys to select the menu item Call as User and then press the key Ⓜ , the menu User List appears (see manual). Now the User can be changed prior to dialling. The change affects the current call only.

If you use the cursor keys to select the menu item Save no. in Directory and then press the key Ⓜ , the menu Directory Input appears (see manual). Here the entry may be edited and used in the telephone book.

If you use the cursor keys to select the menu item Dial and then press the key Ⓜ , the current telephone number is dialled immediately.

If you use the cursor keys to select the menu item Number Present. and then press the key Ⓜ , the number presentation is switched. The change affects the current call only.

If you press the key Ⓡ (long), the current telephone number is dialled immediately, regardless of the menu item currently selected.

With Number Presentation On/Off you can select, weather the own calling number or name will be displayed at the called subscriber.

2.3.3.3 Dialling during existing Connections

During existing connections all entered digits (0 – 9, *, #) are transmitted as DTMF signals. Using this DTMF procedure it is possible to access menu-controlled services (e. g. answering machines, voice boxes) directly via the telephone keypad.

2.3.4 Redialling

Up to 100 of the last numbers dialled are saved automatically, together with the time and date, and can be dialled again.

01 06.02.10 11:30	
Martin 73	
02 06.02.10 11:30	↳
Thomas 70	
03 06.03.10 11:29	↳
Peter 36	
< Calls (outbound)	

Figure 18: List of Recently Dialled Numbers and Sent Messages

Dialling numbers from the redial list

1. In the initial condition, press the key  (long). The list of numbers dialled last is displayed (see Figure 18).

Success (connected/not connected).

The symbol  on the display indicates that there has been a successful call. A not connected call will be displayed without a symbol.



The symbol  on the display indicates that there has been a redirected call.

The symbol  on the display indicates that there has been a transferred call.

The symbol  on the display indicates that there has been a dialled number on a locked telephone.

The symbol  on the display indicates that there has been an automatic call.

The symbol  on the display indicates that there has been a message sent.

2. Use the arrow keys to select the desired entry.
3. Respectively to the wanted calling mode, you can setup the call as follows:
 - a. Lift off the handset (handset mode).
 - b. Press the loudspeaker key  (hands free mode).
 - c. Press the headset key (Key  long (longer than a second) and then the loudspeaker key  (headset mode).

- d. Press key $\text{\textcircled{R}}$ (short or long) or the key $\text{\textcircled{P}}$. With a configured headset you will reach the headset mode otherwise the hands free mode.

2.3.5 Call Back

Up to 100 of the last incoming calls are saved automatically, together with the time and date, and can be called back, if the number of the caller was transmitted.

01	06.02.10	11:30	
Martin 73			
02	06.02.10	11:30	$\text{\textcircled{H}}$
Thomas 70			
03	06.03.10	11:29	$\text{\textcircled{P}}$
Peter 36			
< Calls (inbound)			

Figure 19: List of the Last Incoming Calls and Received Messages

Dialling numbers from the calling list

1. In the initial condition, press the key $\text{\textcircled{R}}$ (short). The list of the last incoming calls is displayed (see Figure 19).

Success (connected/not connected).

The symbol $\text{\textcircled{P}}$ on the display indicates that there has been a call.

The symbol $\text{\textcircled{H}}$ on the display indicates that there has been a redirected call.

The symbol $\text{\textcircled{T}}$ on the display indicates that there has been a transferred call.

The symbol $\text{\textcircled{L}}$ on the display indicates that there has been a dialled number on a locked telephone.

The symbol $\text{\textcircled{A}}$ on the display indicates that there has been an automatic call.

The symbol $\text{\textcircled{M}}$ on the display indicates that there has been a message received.

2. Use the arrow keys to select the desired entry.
3. Respectively to the wanted calling mode, you can setup the call as follows:
 - a. Lift off the handset (handset mode).
 - b. Press the loudspeaker key $\text{\textcircled{L}}$ (hands free mode).
 - c. Press the headset key (Key $\text{\textcircled{H}}$ long (longer than a second) and then the loudspeaker key $\text{\textcircled{L}}$) (headset mode).
 - d. Press key $\text{\textcircled{R}}$ (short or long) or the key $\text{\textcircled{P}}$. With a configured headset you will reach the headset mode otherwise the hands free mode.



2.3.6 Muting

You can mute the microphone during a call to make a confidential enquiry in the room without being heard on the phone.

Torsten	72
Thomas	77
🔇	06.01.10 14:40 0:22

Figure 20: Muting

Press the key  during a call for more than a second. The microphone symbol "🔇" flashes (see Figure 20). The microphone is switched off. You can now make a room enquiry.



Press the Mute key  during a call for more than a second again. The flashing microphone symbol  disappears and the microphone is switched on again.

2.3.7 Making second Call



The line can be put on hold during a call. With the call on hold, you can make a second call to someone else. The person on hold can't hear the second call. The hold function is also needed to switch or transfer a call.

Torsten	72
🔇 Peter	36
Torsten	72
Please dial	
🔇	06.01.10 14:40 0:22

Figure 21: Holding a Call

1. Press the key  (short) during a call. The call is put on hold. You hear a dial tone. The line on hold is displayed normally, the active line inversely (see Figure 21).
2. Dial the call number. A further connection is established.
3. To terminate the enquiry call, press the key . You return to the conversation partner previously put on hold.

Tip

The call with the conversation partner highlighted on the display (active) is terminated by pressing the key . If you alternatively want to terminate a call with another conversation partner, first select the respective conversation partner whose connection you want to disconnect using the arrow keys and only then press the key .

2.3.8 Switching

You can switch between two connections using the switch function.

Torsten	72
Peter	36
Torsten	72
📞 Thomas	70
📞 06.01.10 14:40 0:22	

Figure 22: Switching

1. Press the key \textcircled{R} (short) two times or the key \textcircled{R} (short) followed by the key $\textcircled{2}$ during a call with an active line and a line on hold. The active line is put on hold and the line on hold is activated (see Figure 22).
2. To terminate the active line, you must press the key $\textcircled{\leftrightarrow}$. The connection to the active conversation partner is terminated.

Please note also the tip in chapter 2.3.7 "Making second Call" beginning on page 26.

2.3.9 Transferring a Call



You are making a call and would like to transfer it to another party.

Torsten	72
Peter	36
Torsten	72
📞 Thomas	70
📞 06.01.10 14:40 0:22	

Figure 23: Transferring a Call

1. Press the key \textcircled{R} (short) during a call.
The call is put on hold. You hear a dial tone. The line on hold is displayed normally and the active line inversely.
2. Dial the call number of your choice.
The connection is established. If the called party answers, this can be treated like a second call, as above.
3. To connect the caller will be connected with the dialled number you have the following possibilities:
 - a. Put the handset back on its rest (handset mode).
 - b. Press the loudspeaker key $\textcircled{\leftarrow}$ (hands free mode).
 - c. Press the headset key (Key $\textcircled{\text{H}}$ long (longer than a second) and then the loudspeaker key $\textcircled{\leftarrow}$) (headset mode).

- d. Press the key $\text{\textcircled{R}}$ (short) followed by the key $\text{\textcircled{4}}$. The caller will be connected with the dialled number.

	<p>Tip</p> <p>When transferring a call, you do not have to wait until the desired subscriber answers. You can hang up immediately after dialling the phone number.</p>	
---	---	---

2.3.10 Transferring a Call directly

You are making a call and want to switch it to another connection.

Torsten	72
Peter	36
Transfer 1	

Figure 24: Transferring a Call Directly

1. Press the key $\text{\textcircled{R}}$ (long) during a call.
2. You will be left. The actual connection will not be displayed.
3. Dial the call number of your choice.
4. Press the key $\text{\textcircled{R}}$ (short) or key $\text{\textcircled{▶}}$.
5. The caller will be connected with the dialled port directly.
6. With handset mode hang up.

2.3.11 Initiating a Conference

You can use this function to set up a conference between two lines. To do so, you need an active line and a line on hold (refer to chapter 2.3.7 "Making second Call" beginning on page 26).













Torsten	72
anonym	
Torsten	72
 Peter	36
3party	
 06.01.10 14:40	0:22

Figure 25: Conference



1. Press the key  or the key  (short) followed by the key  during a call with an active line and a line on hold.
A conference is set up between the active line and the line on hold. All the subscribers can now talk with each other (see Figure 25).
2. You can end the conference by pressing the key  respective the key  (short) followed by the key  or twice the key  (short). If you end the conference with pressing the key  or the key  (short) followed by the key , the call put on hold prior to the initiated conference is now on hold again and the previously active call is active once again. If you end the conference with pressing the key  (short) twice, the call put on hold prior to the initiated conference is now active and the previously active call is now on hold.
3. To terminate the active line, you must press the key . The connection to the active conversation partner is terminated. Please note also the tip in chapter 2.3.7.

Note

If you

hang up (handset mode)

press the loudspeaker key (hands free mode)

press the headset key (Key  long (longer than a second) and then the loudspeaker key  (headset mode)

during the conference, the lines of both parties keep connected.

3 Technical Data weatherproof Telephones

Hardware-ID	103
Connection data	
Power supply	Power over Ethernet refer to IEEE 802.3af or external power supply
Voltage PoE	48V DC (Min. 44V, Max. 57V)
PoE	Class 0
Voltage external power supply without using the optional voltaic separated inputs	15 V – 57 V DC
Voltage external power supply for using the optional voltaic separated inputs	21.5 V – 57 V DC
Power	12.95 W
Breaking capacity relay (optional)	240 V, 6 A, AC 24 V, 6 A, DC 32 V, 5 A, DC 48 V, 1 A, DC
Connection	RJ45 Port (10/100 Mbit/s)
Ringing volume	Max. 95 dB(A) in 1 m distance
Housing (Height x Width x Depth) without Cable Glands	267 x 225 x 132 mm
Weight (default version)	ca. 5.0 kg
Display	<ul style="list-style-type: none"> • 182 x 64 pixel • Field of view ca. 78 mm x 26 mm
Keypad	<ul style="list-style-type: none"> • Metal keypad with ice protection • 21 keys with ABC marking
Hook switch	Reed contact without mechanical switch
Operating utilization position	Vertical wall mounting
Handset	
Mouthpiece	Electret-foil microphone
Receiver inset	Dynamic receiver inset with magnetic field generator
Sling holder	Integrated adjustable sling holder
Handset cable	Armed or Spiral court
Environmental conditions	
Ambient operating temperature	-40°C...+70°C
Transport and storage temperature	-40°C...+80°C
Degree of protection	IP66 acc. to IEC 60529
Degree of protection against external mechanical impacts	IK09 acc. to EN IEC 62262
User interface	
Web-interface (administration)	English
Telephone (user menu)	16 languages adjustable

3.1 CE symbol

We hereby declare this product is in compliance with the Essential Health and Safety Requirements of
EMC Directive 2014/30/EU,
Low Voltage Directive 2014/35/EU and
RoHS Directive 2011/65/EU.

The appropriate standards, technical regulations und specifications you can take from the attached conformity declaration and the conformity declarations on our Website

3.2 Use in marine and offshore segments

The telephone ResistTel IP2 is certified by DNV-GL for use in the marine and offshore sector acc. to IEC 60945 and DNVGL-CG-0339. The device is classified as follow:

Certificate No.	Temperature	Humidity	Vibration	EMC	Enclosure
TA00000RT	D	B	A	B	C



The following safe distances must be observed:

to the Standard-Magnetic-compass

1,10 m (reduced 0,55 m)

to the Steering-Magnetic-compass

0,70 m (reduced 0,35 m)

	 NOTE
For the operation on the bridge of the ship, the maximum prescribed ringer volume of 75-85 dB(A) must not be exceeded. Therefore the factory settings of the telephone must be adjusted.	

On the web interface of the telephone at Phone/User-x/Preferences with x=1...6 the ringing tones of all call types (Internal Calls, External Calls, Returned Calls, Offered Calls, Announcement Calls, Multicast Announcement Calls, Messages, Do not Disturb and, if activated, ring filter) for all used registrations have to be limited to the volume **5** of the default melody (3tone1) and the default speed (5).

With the user interface of the telephone the ring tones of the call types (Internal Calls, External Calls, Returned Calls und Message) can be limited to the same setups.

Furthermore you have to pay attention, that during an active incoming call the volume, will not be increased with the volume keys of the telephone above the allowed step **5**.

Subject to alterations or errors

Copyright ©

FHF Funke + Huster Fernsig GmbH · Gewerbeallee 15-19 · D-45478 Mülheim an der Ruhr · Germany
Phone +49 - 208 - 82 68 - 0 · Fax +49 - 208 - 82 68 - 286 · Mail info@fhf.de · www.fhf.de
Orders: fhf-orders@eaton.com · Requests: fhf-sales@eaton.com · Support: fhf-support@eaton.com



Powering Business Worldwide

Eaton's Crouse-Hinds Business
1201 Wolf Street · Syracuse, NY 13208
(866) 764-5454
crouse.customerctr@cooperindustries.com

Eaton is a registered trademark.
All other trademarks are property
of their respective owners.